

# PRCM Series

## Cylindrical connector type proximity sensor

### ■ Features

- Shorten the time of maintenance
- Improved the noise resistance with dedicated IC (DC 3-wire type)
- Reverse power polarity (DC 3-wire), surge, overcurrent protection (DC type)
- Red LED status indication
- IP67 rated waterproof structure (IEC standard)
- Replacer for micro switches and limit switches



**!** Please read "Caution for your safety" in operation manual before using.



### ■ Specifications

#### ● DC 2-wire type

| Model                            | PRCMT12-2DO<br>PRCMT12-2DC  | PRCMT12-4DO<br>PRCMT12-4DC | PRCMT18-5DO<br>PRCMT18-5DC | PRCMT18-8DO<br>PRCMT18-8DC | PRCMT30-10DO<br>PRCMT30-10DC | PRCMT30-15DO<br>PRCMT30-15DC |
|----------------------------------|---|----------------------------|----------------------------|----------------------------|------------------------------|------------------------------|
| Sensing distance                 | 2mm ±10%  | 4mm ±10%                   | 5mm ±10%                   | 8mm ±10%                   | 10mm ±10%                    | 15mm ±10%                    |
| Hysteresis                       | Max. 10% of sensing distance  |                            |                            |                            |                              |                              |
| Standard sensing target          | 12×12×1mm (Iron)  |                            | 18×18×1mm (Iron)           | 25×25×1mm (Iron)           | 30×30×1mm (Iron)             | 45×45×1mm (Iron)             |
| Setting distance                 | 0 ~ 1.4mm   | 0 ~ 2.8mm                  | 0 ~ 3.5mm                  | 0 ~ 5.6mm                  | 0 ~ 7mm                      | 0 ~ 10.5mm                   |
| Power supply (Operation voltage) | 24VDC (15~30VDC)  |                            |                            |                            |                              |                              |
| Leakage current                  | Max. 0.6mA  |                            |                            |                            |                              |                              |
| Response frequency(*1)           | 1.5kHz  | 500Hz                      |                            | 350Hz                      | 400Hz                        | 200Hz                        |
| Residual voltage                 | Max. 7V   |                            |                            |                            |                              |                              |
| Affection by Temp.               | ±10% Max. for sensing distance at +20°C within temperature range of -25 ~ +70°C   |                            |                            |                            |                              |                              |
| Control output                   | 2 ~ 100mA   |                            |                            |                            |                              |                              |
| Dielectric strength              | Min. 50MΩ (at 500VDC mega)  |                            |                            |                            |                              |                              |
| Insulation resistance            | 1500VAC 50/60Hz for 1 minute  |                            |                            |                            |                              |                              |
| Vibration                        | 1mm amplitude at frequency of 10 ~ 55Hz in each of X, Y, Z directions for 2 hours |                            |                            |                            |                              |                              |
| Shock                            | 500m/s <sup>2</sup> (50G) in X, Y, Z directions for 3 times                       |                            |                            |                            |                              |                              |
| Indicator                        | Operation indicator (Red LED)   |                            |                            |                            |                              |                              |
| Ambient temperature              | -25 ~ +70°C (at non-freezing status)  |                            |                            |                            |                              |                              |
| Storage temperature              | -30 ~ +80°C (at non-freezing status)  |                            |                            |                            |                              |                              |
| Ambient humidity                 | 35 ~ 95%RH  |                            |                            |                            |                              |                              |
| Protection circuit               | Surge protection circuit, Overload & Short circuit protection                     |                            |                            |                            |                              |                              |
| Protection                       | IP67 (IEC standard)   |                            |                            |                            |                              |                              |
| Approval                         | CE  |                            |                            |                            |                              |                              |
| Unit weight                      | Approx. 26g   |                            | Approx. 49g                |                            | Approx. 134g                 |                              |

※ (\*1) The response frequency is the average value. The standard sensing target is used and the width is set as 2 times of the standard sensing target, 1/2 of the sensing distance for the distance.

※ IEC standard item is available and add "-I" to the end of model. Ex) PRCM12-4DO-I

※ See J-48 for IEC standard connector cables and specifications.

# Cylindrical Connector Type

## ■ Specifications

### ● DC 3-wire type

| Model                            | PRCM12-2DN<br>PRCM12-2DP<br>PRCM12-2DN2<br>PRCM12-2DP2                            | PRCM12-4DN<br>PRCM12-4DP<br>PRCM12-4DN2<br>PRCM12-4DP2 | PRCM18-5DN<br>PRCM18-5DP<br>PRCM18-5DN2<br>PRCM18-5DP2<br>PRCML18-5DN<br>PRCML18-5DP<br>PRCML18-5DN2<br>PRCML18-5DP2 | PRCM18-8DN<br>PRCM18-8DP<br>PRCM18-8DN2<br>PRCM18-8DP2<br>PRCML18-8DN<br>PRCML18-8DP<br>PRCML18-8DN2<br>PRCML18-8DP2 | PRCM30-10DN<br>PRCM30-10DP<br>PRCM30-10DN2<br>PRCM30-10DP2<br>PRCML30-10DN<br>PRCML30-10DP<br>PRCML30-10DN2<br>PRCML30-10DP2 | PRCM30-15DN<br>PRCM30-15DP<br>PRCM30-15DN2<br>PRCM30-15DP2<br>PRCML30-15DN<br>PRCML30-15DP<br>PRCML30-15DN2<br>PRCML30-15DP2 |
|----------------------------------|---|--|--|--|--|--|
| Sensing distance                 | 2mm ±10%  | 4mm ±10%   | 5mm ±10%   | 8mm ±10%   | 10mm ±10%  | 15mm ±10%  |
| Hysteresis                       | Max. 10% of sensing distance  |  |  |  |  |  |
| Standard sensing target          | 12×12×1mm (Iron)  |  | 18×18×1mm (Iron)   | 25×25×1mm (Iron)   | 30×30×1mm (Iron)   | 45×45×1mm (Iron)   |
| Setting distance                 | 0 ~ 1.4mm   | 0 ~ 2.8mm  | 0 ~ 3.5mm  | 0 ~ 5.6mm  | 0 ~ 7mm  | 0 ~ 10.5mm   |
| Power supply (Operation voltage) | 12-24VDC<br>(10-30VDC)  |  |  |  |  |  |
| Current consumption              | Max. 10mA   |  |  |  |  |  |
| Response frequency(*1)           | 1.5kHz  | 500Hz  | 350Hz  | 400Hz  | 200Hz  |  |
| Residual voltage                 | Max. 1.5V   |  |  |  |  |  |
| Affection by Temp.               | ±10% Max. for sensing distance at +20°C within temperature range of -25 ~ +70°C   |  |  |  |  |  |
| Control output                   | Max. 200mA  |  |  |  |  |  |
| Dielectric strength              | Min. 50MΩ (at 500VDC mega)  |  |  |  |  |  |
| Insulation resistance            | 1500VAC 50/60Hz for 1 minute  |  |  |  |  |  |
| Vibration                        | 1mm amplitude at frequency of 10 ~ 55Hz in each of X, Y, Z directions for 2 hours |  |  |  |  |  |
| Shock                            | 500m/s <sup>2</sup> (50G) in X, Y, Z directions for 3 times                       |  |  |  |  |  |
| Indicator                        | Operation indicator (Red LED)   |  |  |  |  |  |
| Ambient temperature              | -25 ~ +70°C (at non-freezing status)  |  |  |  |  |  |
| Storage temperature              | -30 ~ +80°C (at non-freezing status)  |  |  |  |  |  |
| Ambient humidity                 | 35 ~ 95%RH  |  |  |  |  |  |
| Protection circuit               | Surge, Reverse power polarity, Overcurrent protection circuit                     |  |  |  |  |  |
| Protection                       | IP67 (IEC standard)   |  |  |  |  |  |
| Approval                         | CE  |  |  |  |  |  |
| Unit weight                      | Approx. 26g   |  | PRCM18 : Approx. 49g<br>PRCML18 : Approx. 73g  |  | PRCM30 : Approx. 134g<br>PRCML30 : Approx. 169g  |  |

※ (\*1) The response frequency is the average value. The standard sensing target is used and the width is set as 2 times of the standard sensing target, 1/2 of the sensing distance for the distance.

### ● AC 2-wire type

| Model                            | PRCM12-2AO<br>PRCM12-2AC  | PRCM12-4AO<br>PRCM12-4AC | PRCM18-5AO<br>PRCM18-5AC<br>PRCML18-5AO<br>PRCML18-5AC | PRCM18-8AO<br>PRCM18-8AC<br>PRCML18-8AO<br>PRCML18-8AC | PRCM30-10AO<br>PRCM30-10AC<br>PRCML30-10AO<br>PRCML30-10AC | PRCM30-15AO<br>PRCM30-15AC<br>PRCML30-15AO<br>PRCML30-15AC |
|----------------------------------|---|--------------------------|--|--|--|--|
| Sensing distance                 | 2mm ±10%  | 4mm ±10%                 | 5mm ±10%   | 8mm ±10%   | 10mm ±10%  | 15mm ±10%  |
| Hysteresis                       | Max. 10% of sensing distance  |                          |  |  |  |  |
| Standard sensing target          | 12×12×1mm (Iron)  |                          | 18×18×1mm (Iron)                                       | 25×25×1mm (Iron)                                       | 30×30×1mm (Iron)   | 45×45×1mm (Iron)   |
| Setting distance                 | 0 ~ 1.4mm   | 0 ~ 2.8mm                |  | 0 ~ 5.6mm  | 0 ~ 7mm  | 0 ~ 10.5mm   |
| Power supply (Operation voltage) | 100-240VAC<br>(85-264VAC)   |                          |  |  |  |  |
| Leakage current                  | Max. 2.5mA  |                          |  |  |  |  |
| Response frequency(*1)           | 20Hz  |                          |  |  |  |  |
| Residual voltage                 | Max. 10V  |                          |  |  |  |  |
| Affection by Temp.               | ±10% Max. for sensing distance at +20°C within temperature range of -25 ~ +70°C   |                          |  |  |  |  |
| Control output                   | 5 ~ 150mA   |                          |  | 5 ~ 200mA  |  |  |
| Dielectric strength              | Min. 50MΩ (at 500VDC mega)  |                          |  |  |  |  |
| Insulation resistance            | 2500VAC 50/60Hz for 1 minute  |                          |  |  |  |  |
| Vibration                        | 1mm amplitude at frequency of 10 ~ 55Hz in each of X, Y, Z directions for 2 hours |                          |  |  |  |  |
| Shock                            | 500m/s <sup>2</sup> (50G) in X, Y, Z directions for 3 times                       |                          |  |  |  |  |
| Indicator                        | Operation indicator (Red LED)   |                          |  |  |  |  |
| Ambient temperature              | -25 ~ +70°C (at non-freezing status)  |                          |  |  |  |  |
| Storage temperature              | -30 ~ +80°C (at non-freezing status)  |                          |  |  |  |  |
| Ambient humidity                 | 35 ~ 95%RH  |                          |  |  |  |  |
| Protection circuit               | Surge protection circuit  |                          |  |  |  |  |
| Protection                       | IP67 (IEC standard)   |                          |  |  |  |  |
| Approval                         | CE  |                          |  |  |  |  |
| Unit weight                      | Approx. 30g   |                          | PRCM18 : Approx. 53g<br>PRCML18 : Approx. 74g          |  | PRCM30 : Approx. 134g<br>PRCML30 : Approx. 169g            |  |

※ (\*1) The response frequency is the average value. The standard sensing target is used and the width is set as 2 times of the standard sensing target, 1/2 of the sensing distance for the distance.

(A) Counter

(B) Timer

(C) Temp. controller

(D) Power controller

(E) Panel meter

(F) Tacho/Speed/Pulse meter

(G) Display unit

(H) Sensor controller

(I) Switching power supply

(J) Proximity sensor

(K) Photo electric sensor

(L) Pressure sensor

(M) Rotary encoder

(N) Stepping motor & Driver & Controller

(O) Graphic panel

(P) Production stoppage models & replacement

# PRCM Series

## Dimensions

(Unit:mm)

●PRCM(T)12-2D□

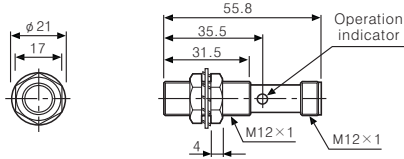

●PRCM(T)12-4D□

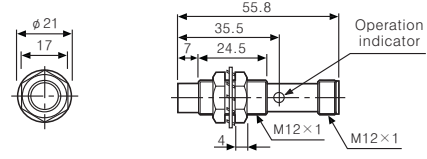

●PRCM(T)18-5D□

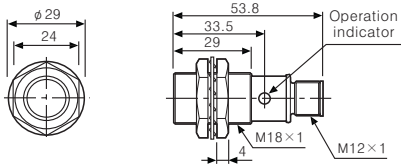

●PRCM(T)18-8D□

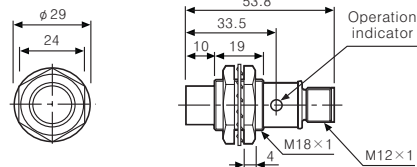

●PRCM(T)30-10D□

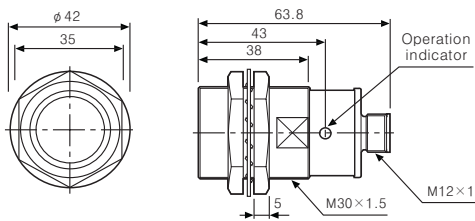

●PRCM(T)30-15D□

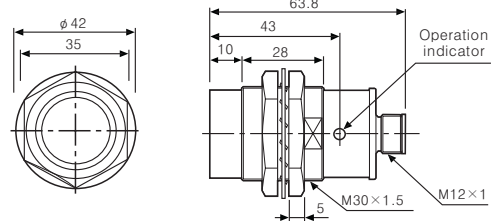

●PRCM12-2A□

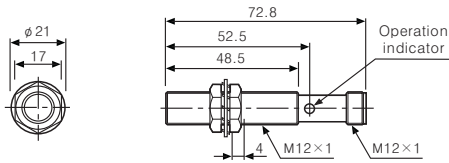

●PRCM12-4A□

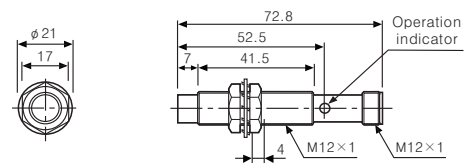

●PRCM18-5A□

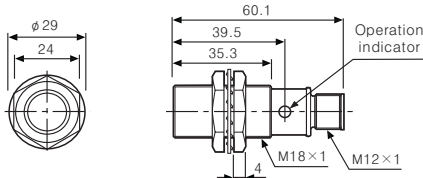

●PRCM18-8A□

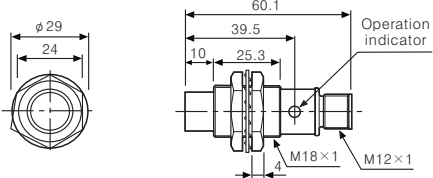

●PRCM30-10A□

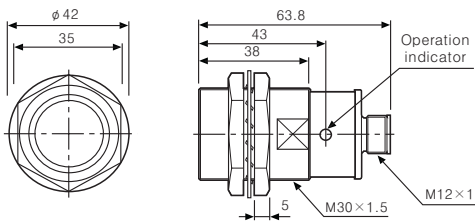

●PRCM30-15A□

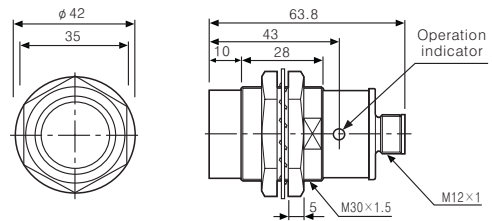

●PRCML18-5D□ / PRCML18-5A□

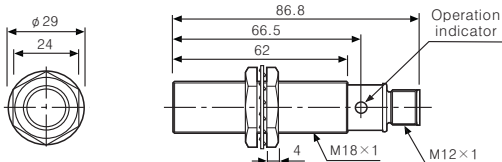

●PRCML18-8D□ / PRCML18-8A□

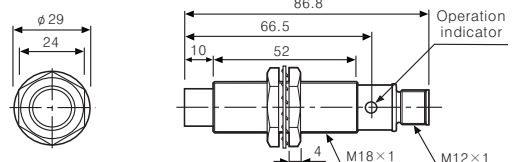

●PRCML30-10D□ / PRCML30-10A□

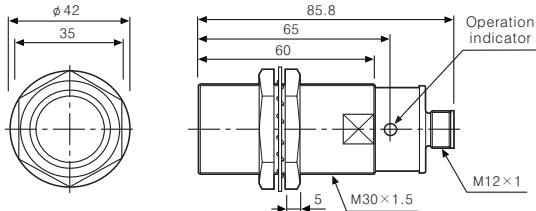

●PRCML30-15D□ / PRCML30-15A□

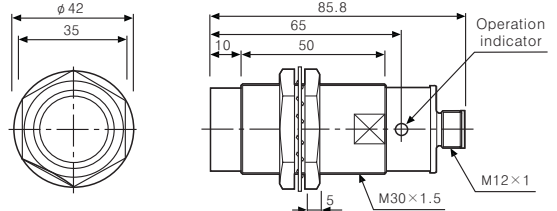

# Cylindrical Connector Type

## Control output diagram

### DC 2-wire type



### DC 3-wire type

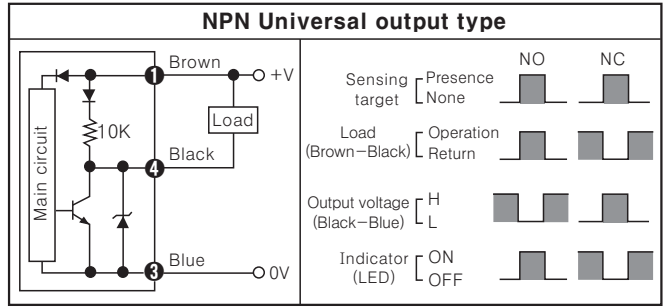

### AC 2-wire type

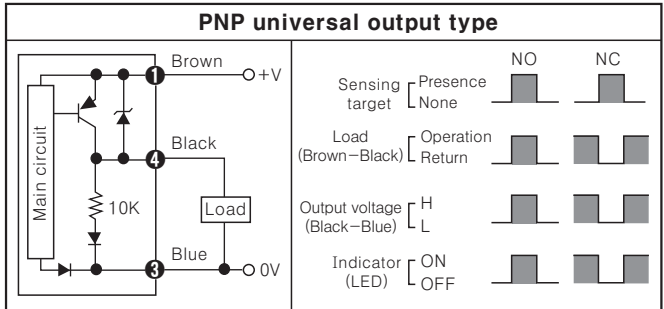

\*The number in a circle is pin no. of connector.

## Wiring diagram

### DC 2-wire type (Standard type)



\*Pin ①, ② are N.C (Not Connected) terminals.  
\*For DC 3-wire type connector cable, it is available to use with black wire (24VDC) and blue wire (0V).

### DC 2-wire type (IEC standard type)



\*The pin arrangement of connector applying IEC standard is being developed.  
\*Please attach "I" at the end of the name of standard type for purchasing the IEC standard product. Ex) PRCMT12-4DO-I  
\*The connector cable for IEC standard is being developed. Please attach "I" at the end of the name of standard type. Ex) CID2-2-I, CLD2-5-I

### DC 3-wire



\*Please fasten the cleat of connector not to shown the thread. (0.39~0.49N·m)

### AC 2-wire



\*In AC inductive type, ② and ③, ① and ④ are connected inside of the connector cable.

\*Please fasten the vibration part with Teflon tape.  
\*See J-48 about IEC standard connector wires and specifications.

(A) Counter

(B) Timer

(C) Temp. controller

(D) Power controller

(E) Panel meter

(F) Tacho/Speed/Pulse meter

(G) Display unit

(H) Sensor controller

(I) Switching power supply

(J) Proximity sensor

(K) Photo electric sensor

(L) Pressure sensor

(M) Rotary encoder

(N) Stepping motor & Driver & Controller

(O) Graphic panel

(P) Production stoppage models & replacement

# PRCM Series

## ■ Proper usage

### ◎ Load connections



When using DC or AC 2-wire type proximity sensor, the load must be connected otherwise internal components may be damaged. And the load can be connected to either wire.

### ◎ In case of the load current is small

#### ● AC 2-wire type

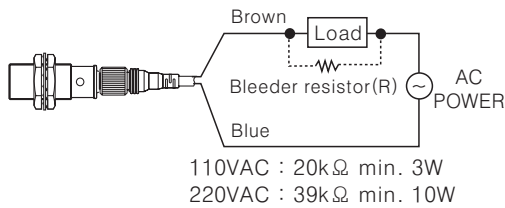

It may cause return failure of load by residual voltage. If the load current is under 5mA, please make sure the residual voltage is less than the return voltage of the load by connecting a bleeder resistor in parallel with the load as shown in the diagram.

$$R = \frac{V_s}{I} \text{ (}\Omega\text{)} \quad P = \frac{V_s^2}{R} \text{ (W)}$$

[ I : Action current of load, R : Bleeder resistance, P : Permissible power ]

#### ● DC 2-wire type

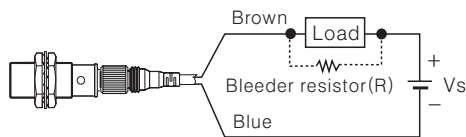

Please make the current on proximity sensor smaller than the return current of load by connecting a bleeder resistor in parallel.  
※ W value of Bleeder resistor should be bigger for proper heat dissipation.

$$R = \frac{V_s}{I_o - I_{off}} \text{ (}\Omega\text{)} \quad P = \frac{V_s^2}{R} \text{ (W)}$$

[ Vs : Power supply, Io : Min. action current of proximity sensor  
Ioff : Return current of load, P : Number of Bleeder resistance watt ]

### ◎ Mutual-interference & Influence by surrounding metals

When several proximity sensors are mounted closely, malfunction of sensor may be caused due to mutual interference. Therefore, be sure to provide a minimum distance between the two sensors, as below charts.

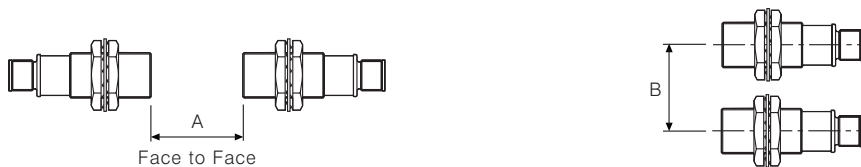

When sensors are mounted on metallic panel, you must prevent the sensors from being affected by any metallic object except target. Therefore, be sure to provide a minimum distance as below chart.



(Unit:mm)

| Model | PRCMT12-2D□              | PRCMT12-4D□              | PRCMT18-5D                   | PRCMT18-8D□                    | PRCMT30-10D□                     | PRCMT30-15D                    |
|-------|--------------------------|--------------------------|------------------------------|--------------------------------|----------------------------------|--------------------------------|
| Item  | PRCM12-2D□<br>PRCM12-2A□ | PRCM12-4D□<br>PRCM12-4A□ | PRCM(L)18-5D<br>PRCM(L)18-5A | PRCM(L)18-8D□<br>PRCM(L)18-8A□ | PRCM(L)30-10D□<br>PRCM(L)30-10A□ | PRCM(L)30-15D<br>PRCM(L)30-15A |
| A     | 12                       | 24                       | 30                           | 48                             | 60                               | 90                             |
| B     | 24                       | 36                       | 36                           | 54                             | 60                               | 90                             |
| l     | 0                        | 11                       | 0                            | 14                             | 0                                | 15                             |
| φ d   | 12                       | 36                       | 18                           | 54                             | 30                               | 90                             |
| m     | 6                        | 12                       | 15                           | 24                             | 30                               | 54                             |
| n     | 18                       | 36                       | 27                           | 54                             | 45                               | 90                             |